

Peak Emission Wavelength: 870nm

The 870nm high power infrared emitter series is designed for applications requiring high accuracy and precision as well as uniform spectral emission. Custom package solutions and sorting are available.

FEATURES

- > Hermetically Sealed TO-46
- > High Output Power
- > High Reliability
- > Narrow Beam Angle

APPLICATIONS

- > Optical Scanning
- > Linear & Rotary Encoder
- > Edge Sensing / Optical Sensors
- > Optical Switches / Security Systems

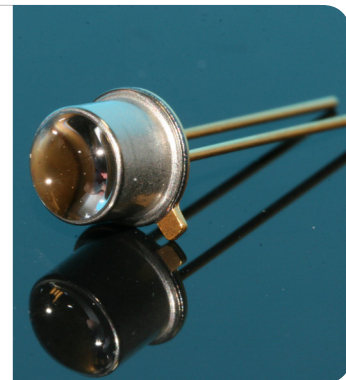

Absolute Maximum Ratings (Ta=25°C)



ITEMS	SYMBOL	RATINGS	UNIT
Forward Current (DC)	IF	100	mA
Forward Current (Pulse)*1	IFP	1	A
Reverse Voltage	VR	5	V
Power Dissipation	PD	200	mW
Operating Temperature Range	Topr	-30 ~ +100	°C
Storage Temperature Range	Tstg	-40 ~ +125	°C
Junction Temperature	Tj	125	°C
Lead Soldering Temperature*2	Tls	260	°C

*1: Tw=10μsec, T=1msec. *2: Time 5 Sec max, Position: Up to 3mm from the body.

Electrical & Optical Characteristics (Ta = 25°C)

ITEMS	SYMBOL	CONDITIONS	MIN	TYP	MAX	UNIT
Power Output	PO	IF=50mA	--	10.0	--	mW
Forward Voltage	VF	IF=50mA	--	1.5	2.0	V
Reverse Current	IR	VR=5V	--	--	100	μA
Peak Emission Wavelength	λp	IF=50mA	--	870	--	nm
Spectral Line Half Width	Δλ	IF=50mA	--	45	--	nm
Half Intensity Beam Angle	Θ	IF=50mA	--	±6	--	deg

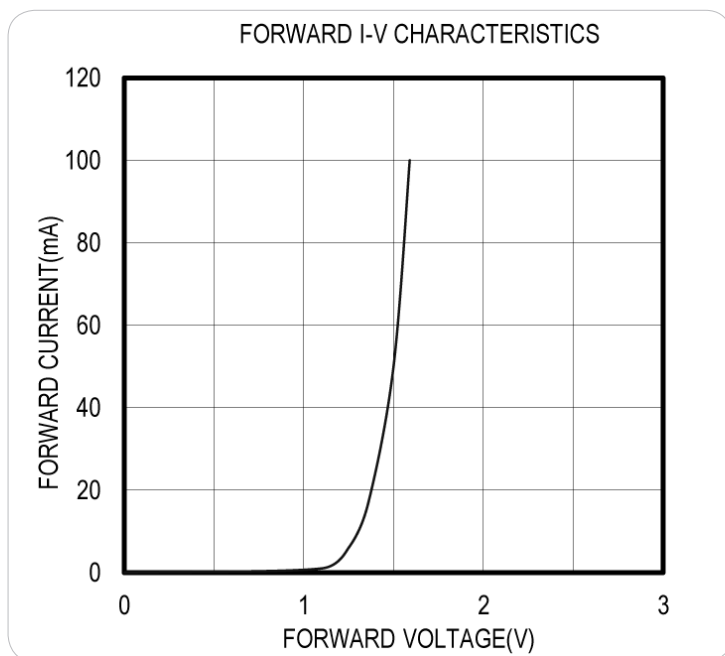
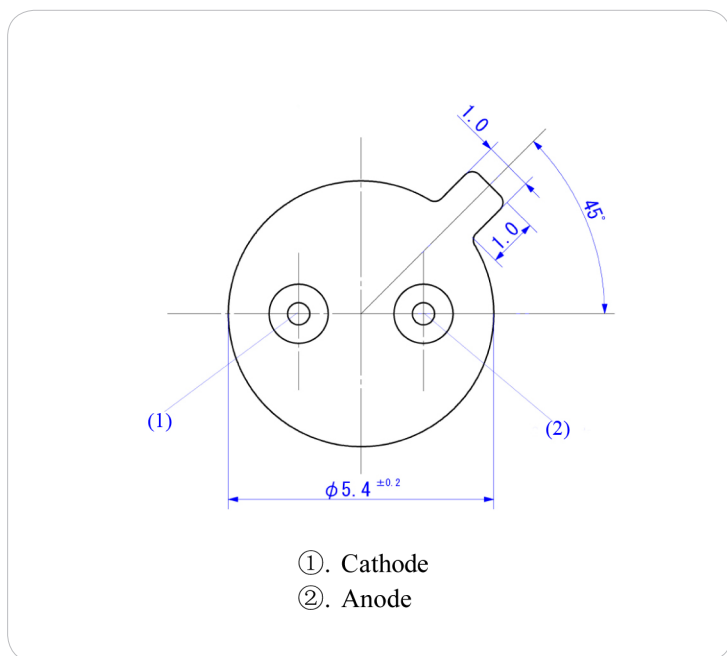
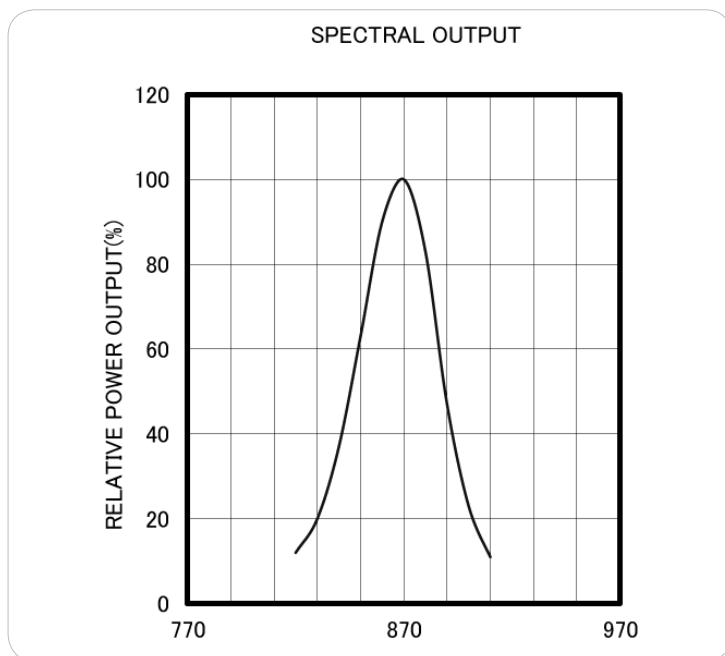
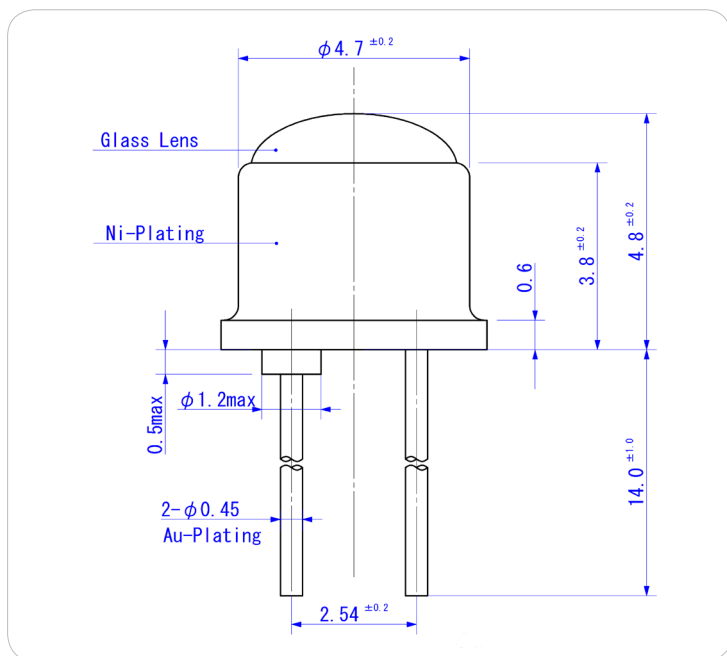

Unit: mm, Tolerance: ± 0.2

RELATIVE POWER vs FORWARD CURRENT

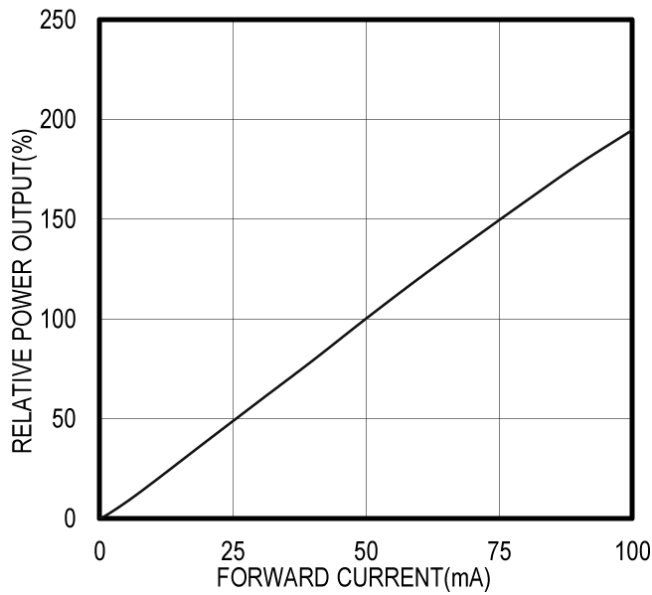

THERMAL DERATING CURVE

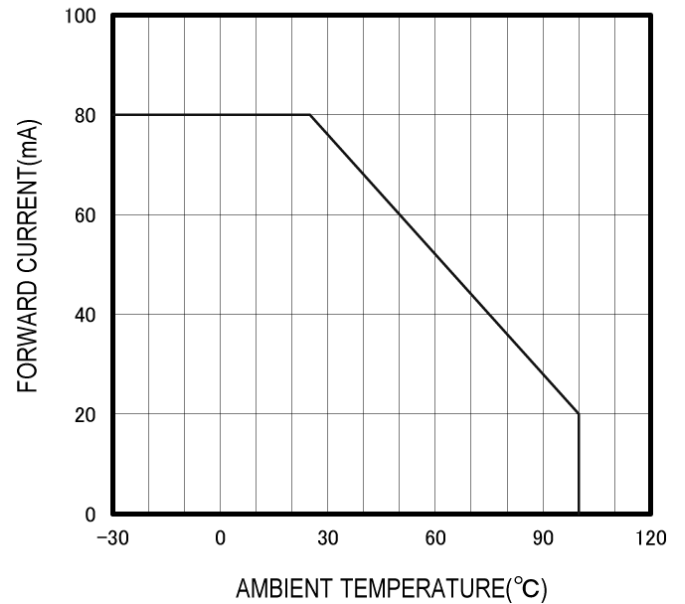

RADIATION PATTERN

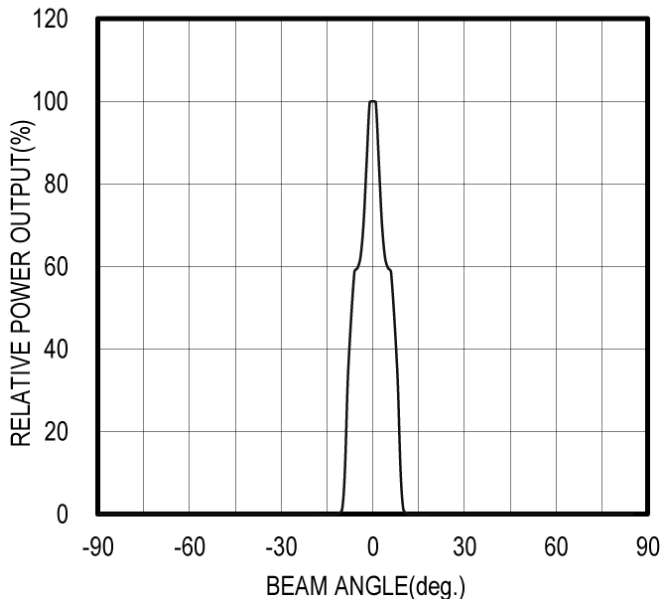

The information contained herein is subject to change without notice.

2014-02-13