

**Product number FA10299\_OSS-RS**

Family	Rose	FWHM	7 degrees
Type	Assembly	Efficiency	90 %
LED	Golden Dragon+	cd/lm	29.600
Color	White	Gerber File	Available
Diameter	21.6 + 21.6 mm		
Height	13.9 mm		
Style	Square		
Optic Material	PC		
Holder Material	-		
Fastening	["tape"]		
Status	Production ready		

**Product number CA10561\_OSS-2-RS**

Family	Rose	FWHM	7 degrees
Type	Assembly	Efficiency	-
LED	Golden Dragon+	cd/lm	35.500
Color	White	Gerber File	Available
Diameter	21.6 + 21.6 mm		
Height	13.9 mm		
Style	Square		
Optic Material	PMMA		
Holder Material	-		
Fastening	["tape"]		
Status	Production ready		

**Product number CA13613\_G2-OSS-2-RS**

Family	Rose	FWHM	7 degrees
Type	Assembly	Efficiency	-
LED	Golden Dragon+	cd/lm	35.500
Color	White	Gerber File	Available
Diameter	21.6*21.6 mm		
Height	13.9 mm		
Style	Square		
Optic Material	PMMA		
Holder Material	-		
Fastening	-		
Status	Production ready		

**Product number FA10300\_OSS-D**

Family	Rose	FWHM	11 degrees
Type	Assembly	Efficiency	87 %
LED	Golden Dragon+	cd/lm	12.700
Color	White	Gerber File	Available
Diameter	21.6 + 21.6 mm		
Height	13.9 mm		
Style	Square		
Optic Material	PC		
Holder Material	-		
Fastening	["tape"]		
Status	Production ready		

**Product number CA13609\_G2-OSS-2-M**

Family	Rose	FWHM	11 degrees
Type	Assembly	Efficiency	90 %
LED	Golden Dragon+	cd/lm	14.780
Color	White	Gerber File	Available
Diameter	21.6*21.6 mm		
Height	13.9 mm		
Style	Square		
Optic Material	PMMA		
Holder Material	-		
Fastening	["tape"]		
Status	Production ready		

**Product number FA10327\_OSS-SS**

Family	Rose	FWHM	12 degrees
Type	Assembly	Efficiency	93 %
LED	Golden Dragon+	cd/lm	13.150
Color	White	Gerber File	Available
Diameter	21.6 + 21.6 mm		
Height	13.9 mm		
Style	Square		
Optic Material	PC		
Holder Material	-		
Fastening	["tape"]		
Status	Production ready		

**Product number CA10560\_OSS-2-SS**

Family	Rose	FWHM	12 degrees
Type	Assembly	Efficiency	92 %
LED	Golden Dragon+	cd/lm	16.000
Color	White	Gerber File	Available
Diameter	21.6 + 21.6 mm		
Height	13.9 mm		
Style	Square		
Optic Material	PMMA		
Holder Material	-		
Fastening	["tape"]		
Status	Production ready		

**Product number FA11145\_OSS-O-90**

Family	Rose	FWHM	12+48 degrees
Type	Assembly	Efficiency	-
LED	Golden Dragon+	cd/lm	-
Color	White	Gerber File	Available
Diameter	21.6 + 21.6 mm		
Height	13.9 mm		
Style	Square		
Optic Material	PC		
Holder Material	-		
Fastening	["tape"]		
Status	Production ready		

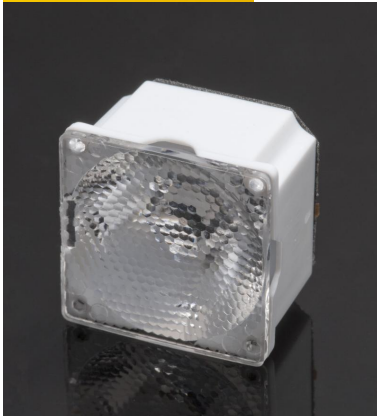
**Product number CA13612\_G2-OSS-2-SS**

Family	Rose	FWHM	12 degrees
Type	Assembly	Efficiency	92 %
LED	Golden Dragon+	cd/lm	16.000
Color	White	Gerber File	Available
Diameter	21.6*21.6 mm		
Height	13.9 mm		
Style	Square		
Optic Material	PMMA		
Holder Material	-		
Fastening	["tape"]		
Status	Production ready		

**Product number CA10559\_OSS-2-D**

Family	Rose	FWHM	13 degrees
Type	Assembly	Efficiency	-
LED	Golden Dragon+	cd/lm	11.210
Color	White	Gerber File	Available
Diameter	21.6 + 21.6 mm		
Height	13.9 mm		
Style	Square		
Optic Material	PMMA		
Holder Material	-		
Fastening	["tape"]		
Status	Production ready		

**Product number CA10572\_OSS-2-O**

Family	Rose	FWHM	13+37 degrees
Type	Assembly	Efficiency	-
LED	Golden Dragon+	cd/lm	4.100
Color	White	Gerber File	Available
Diameter	21.6 + 21.6 mm		
Height	13.9 mm		
Style	Square		
Optic Material	PMMA		
Holder Material	-		
Fastening	["tape"]		
Status	Production ready		

**Product number CA13611\_G2-OSS-2-D**

Family	Rose	FWHM	13 degrees
Type	Assembly	Efficiency	-
LED	Golden Dragon+	cd/lm	11.210
Color	White	Gerber File	Available
Diameter	21.6*21.6 mm		
Height	13.9 mm		
Style	Square		
Optic Material	PMMA		
Holder Material	-		
Fastening	["tape"]		
Status	Production ready		

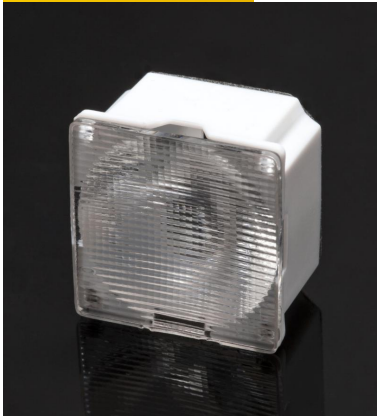
**Product number CA13615\_G2-OSS-2-O**

Family	Rose	FWHM	13+37 degrees
Type	Assembly	Efficiency	-
LED	Golden Dragon+	cd/lm	4.100
Color	White	Gerber File	Available
Diameter	21.6*21.6 mm		
Height	13.9 mm		
Style	Square		
Optic Material	PMMA		
Holder Material	-		
Fastening	["tape"]		
Status	Production ready		

**Product number CA10569\_OSS-2-M**

Family	Rose	FWHM	24 degrees
Type	Assembly	Efficiency	-
LED	Golden Dragon+	cd/lm	4.360
Color	White	Gerber File	Available
Diameter	21.6 + 21.6 mm		
Height	13.9 mm		
Style	Square		
Optic Material	PMMA		
Holder Material	-		
Fastening	["tape"]		
Status	Production ready		

**Product number CA13614\_G2-OSS-2-M**

Family	Rose	FWHM	26 degrees
Type	Assembly	Efficiency	88 %
LED	Golden Dragon+	cd/lm	4.570
Color	White	Gerber File	Available
Diameter	21.6*21.6 mm		
Height	13.9 mm		
Style	Square		
Optic Material	PMMA		
Holder Material	-		
Fastening	["tape"]		
Status	Production ready		

**Product number FA10301\_OSS-M**

Family	Rose	FWHM	30 degrees
Type	Assembly	Efficiency	87 %
LED	Golden Dragon+	cd/lm	2.700
Color	White	Gerber File	Available
Diameter	21.6 + 21.6 mm		
Height	13.9 mm		
Style	Square		
Optic Material	PC		
Holder Material	-		
Fastening	["tape"]		
Status	Production ready		

**Product number FA10302\_OSS-O**

Family	Rose	FWHM	42+11 degrees
Type	Assembly	Efficiency	86 %
LED	Golden Dragon+	cd/lm	4.200
Color	White	Gerber File	Available
Diameter	21.6 + 21.6 mm		
Height	13.9 mm		
Style	Square		
Optic Material	PC		
Holder Material	-		
Fastening	["tape"]		
Status	Production ready		

**Product number FA10342\_OSS-W**

Family	Rose	FWHM	48 degrees
Type	Assembly	Efficiency	84 %
LED	Golden Dragon+	cd/lm	1.000
Color	White	Gerber File	Available
Diameter	21.6 + 21.6 mm		
Height	13.9 mm		
Style	Square		
Optic Material	PC		
Holder Material	-		
Fastening	["tape"]		
Status	Production ready		

**Product number CA12081\_OSS-2-WWW**

Family	Rose	FWHM	80 degrees
Type	Assembly	Efficiency	-
LED	Golden Dragon+	cd/lm	-
Color	White	Gerber File	Available
Diameter	21.6 + 21.6 mm		
Height	13.9 mm		
Style	Square		
Optic Material	PMMA		
Holder Material	-		
Fastening	["tape"]		
Status	Production ready		

**Product number CA13617\_G2-OSS-2-WWW**

Family	Rose	FWHM	80 degrees
Type	Assembly	Efficiency	-
LED	Golden Dragon+	cd/lm	-
Color	White	Gerber File	Available
Diameter	21.6*21.6 mm		
Height	13.9 mm		
Style	Square		
Optic Material	PMMA		
Holder Material	-		
Fastening	["tape"]		
Status	Production ready		



## PRODUCT DATASHEET

### Rose series

last update 9/5/2014

**NOTE: The typical divergence will be changed by different color, chip size and chip position tolerance. The typical total divergence is the full angle measured where the luminous intensity is half of the peak value.**



## PRODUCT DATASHEET

### Rose series

last update 9/5/2014

#### GENERAL INFORMATION

- Product series especially designed & optimized for Golden Dragon+ series of LEDs.
- Special care taken to make light distribution as uniform as possible.
- Lens material optical grade PMMA with high UV and temperature resistance. Allows use of high current and temperature conditions.

Please find more information about used material from below:

[http://ledil.fi/sites/default/files/Documents/Technical/Material/PMMA%20N%20UL94\\_Yellow%20Card.pdf](http://ledil.fi/sites/default/files/Documents/Technical/Material/PMMA%20N%20UL94_Yellow%20Card.pdf)

<http://ledil.fi/sites/default/files/Documents/Technical/Material/PMMA%20N%20PLEXIGLAS-Datasheet.pdf>

- Lens material optical grade PC with high UV and temperature resistance (120 degrees of Celcius / 248 degrees of Fahrenheit). Allows use of high current and temperature conditions.

Please find more information about used materials from below:

[http://ledil.fi/sites/default/files/Documents/Technical/Material/PC%20Makrolon%202400\\_2407\\_2456\\_2458-UL.pdf](http://ledil.fi/sites/default/files/Documents/Technical/Material/PC%20Makrolon%202400_2407_2456_2458-UL.pdf)

Relative intensity of CA13609\_G2-OSS-2-M\_(GD+)

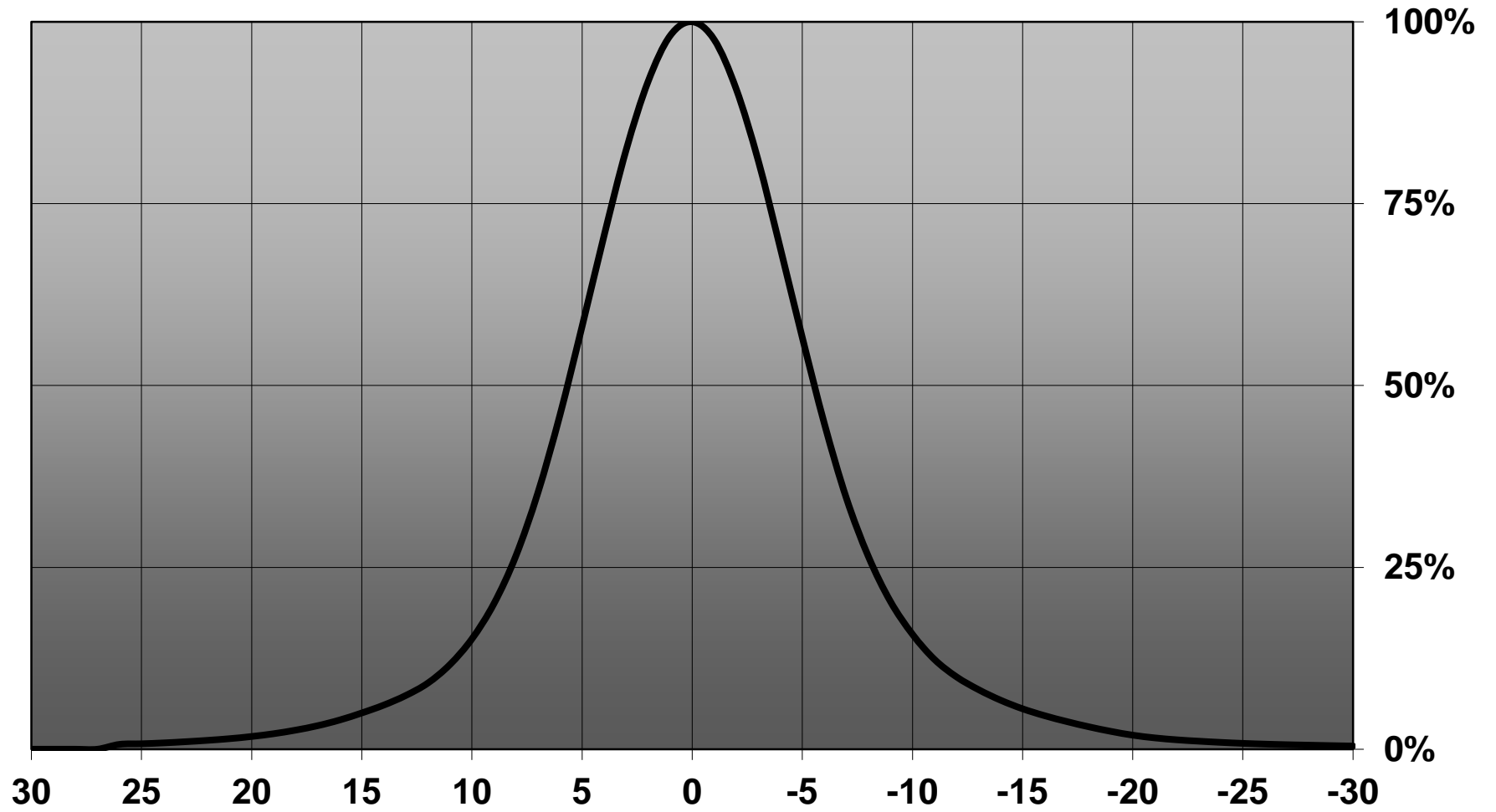



Relative intensity of CA13614\_G2-OSS-2-M\_(GD+)

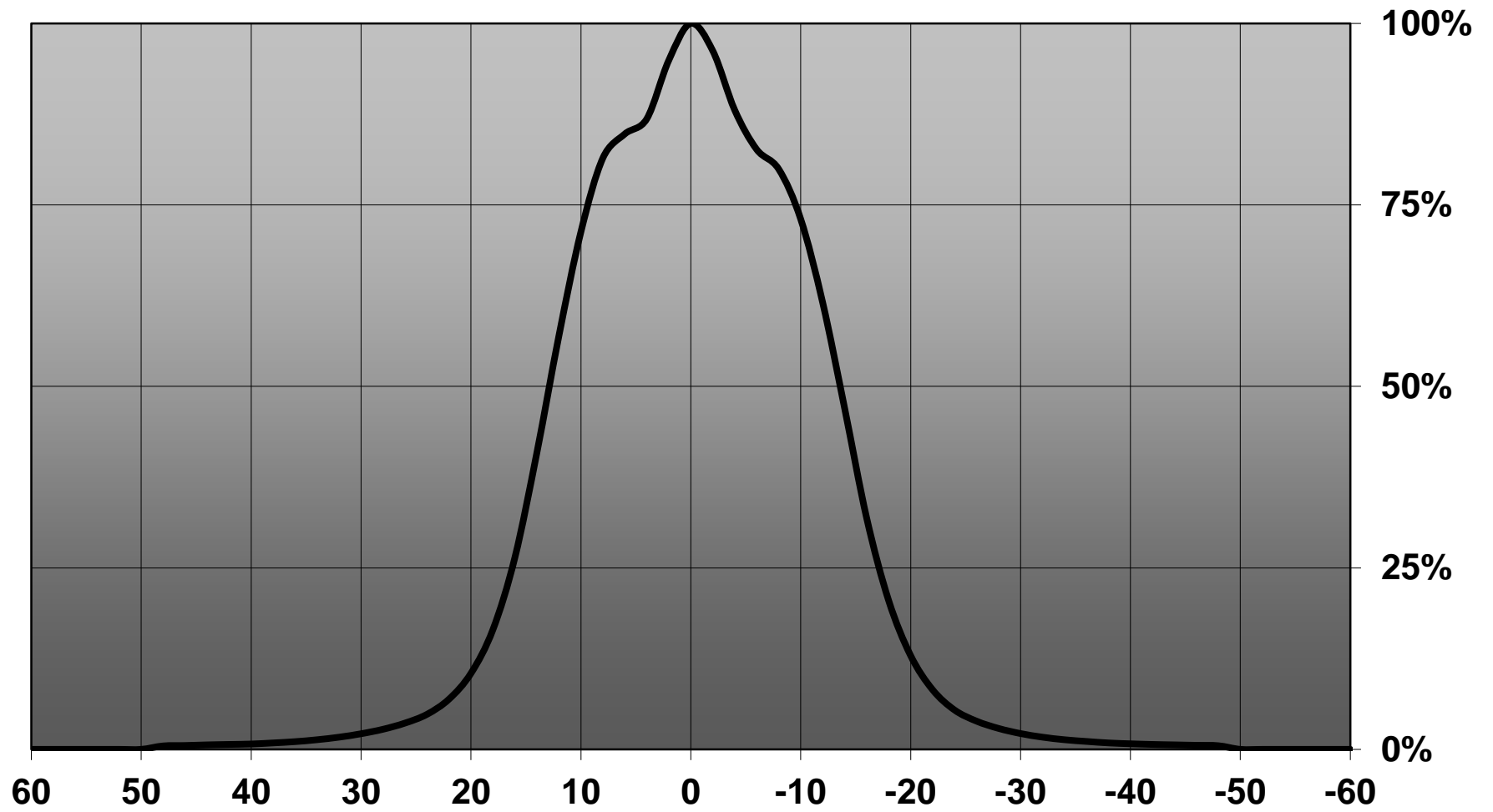

# Ledil Oy FA10299\_OSS-RS FA10299\_OSS-RS / LDC (Linear)

Luminaire: Ledil Oy FA10299\_OSS-RS FA10299\_OSS-RS

Lamps: 1 x Osram-os Golden Dragon+

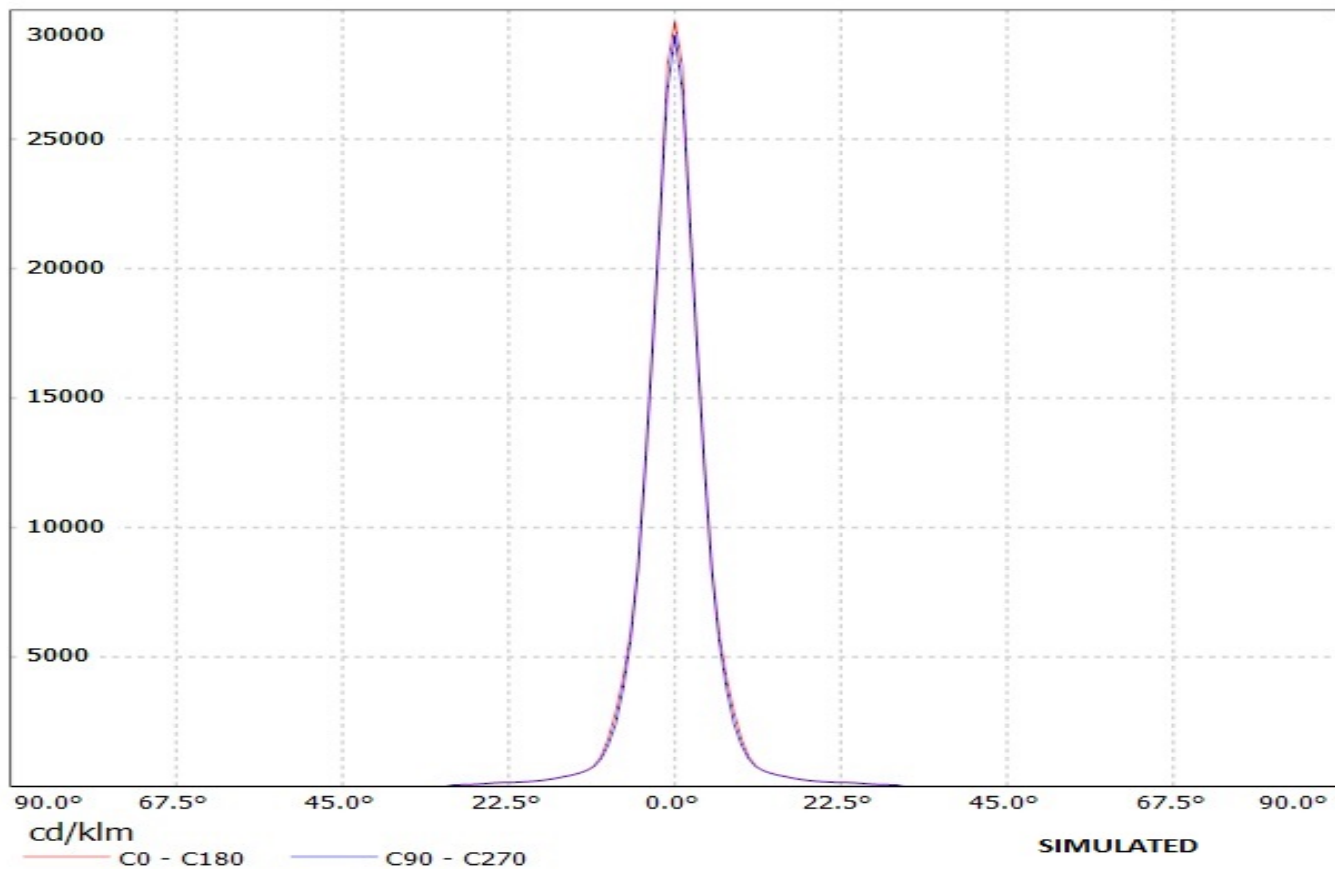

**Ledil oy CA10561\_OSS-2-RS (Golden Dragon+) LOR=92% / LDC (Linear)**

Luminaire: Ledil oy CA10561\_OSS-2-RS (Golden Dragon+) LOR=92%  
Lamps: 1 x Osram Golden Dragon+ 67lm @ 250mA

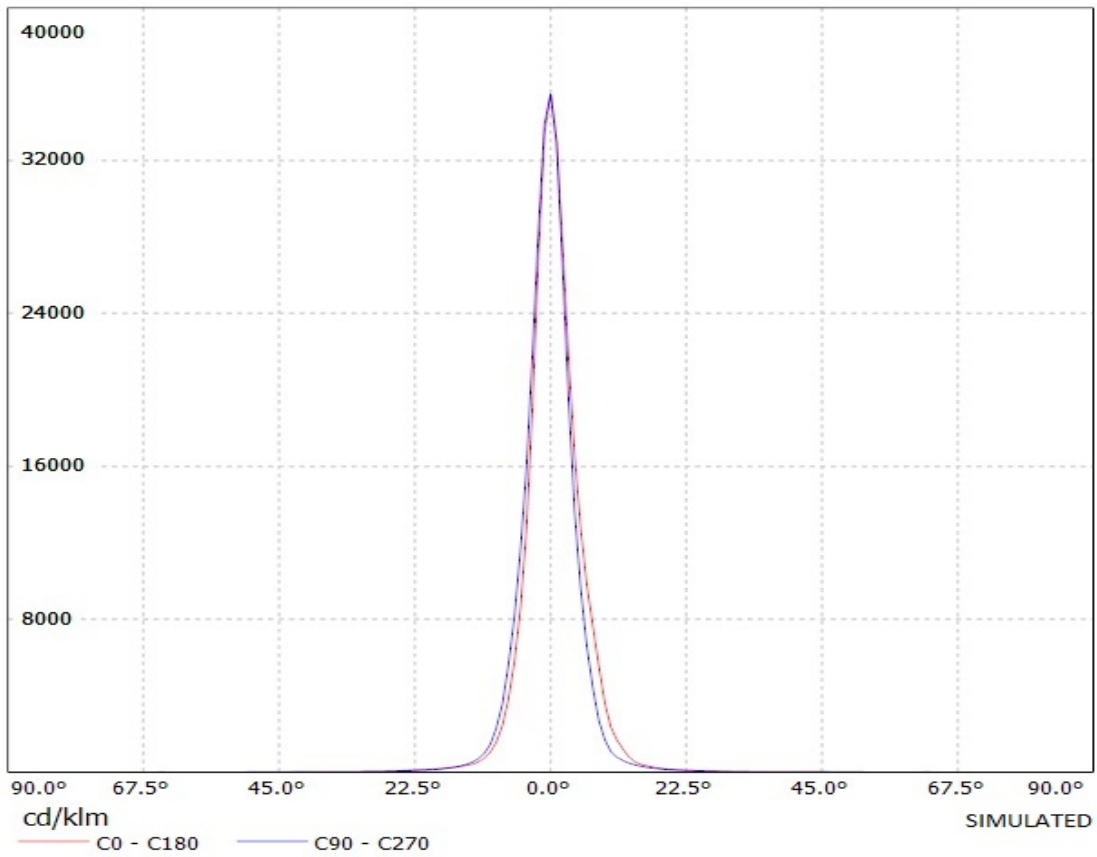

# Ledil Oy FA10300\_OSS-D FA10300\_OSS-D / LDC (Linear)

Luminaire: Ledil Oy FA10300\_OSS-D FA10300\_OSS-D  
Lamps: 1 x OSRAM-OS GOLDEN DRAGON+ (white)

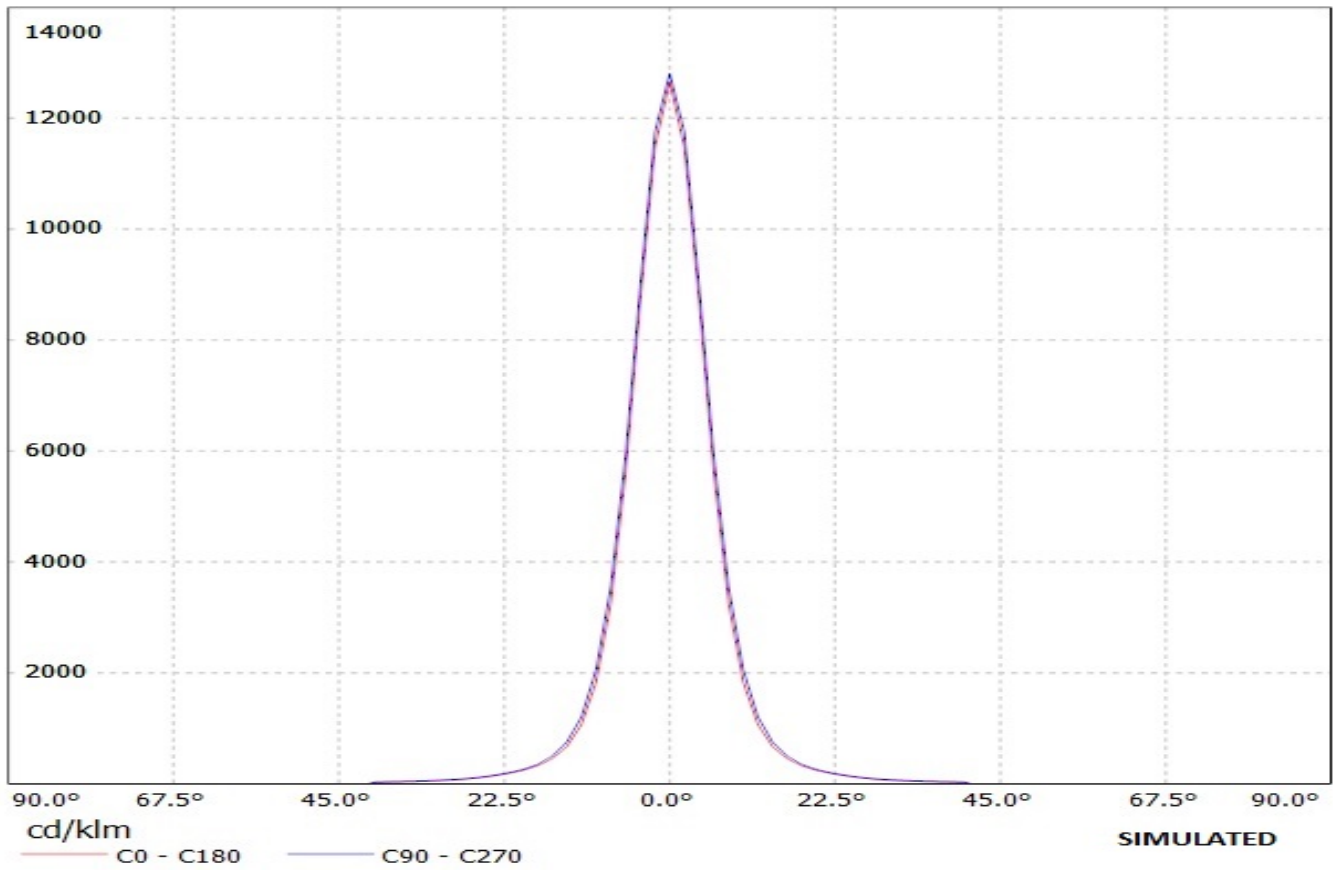

Ledil Oy FA10327\_OSS-SS FA10327\_OSS-SS / LDC (Linear)

Luminaire: Ledil Oy FA10327\_OSS-SS FA10327\_OSS-SS  
Lamps: 1 x Osram-os Golden Dragon+

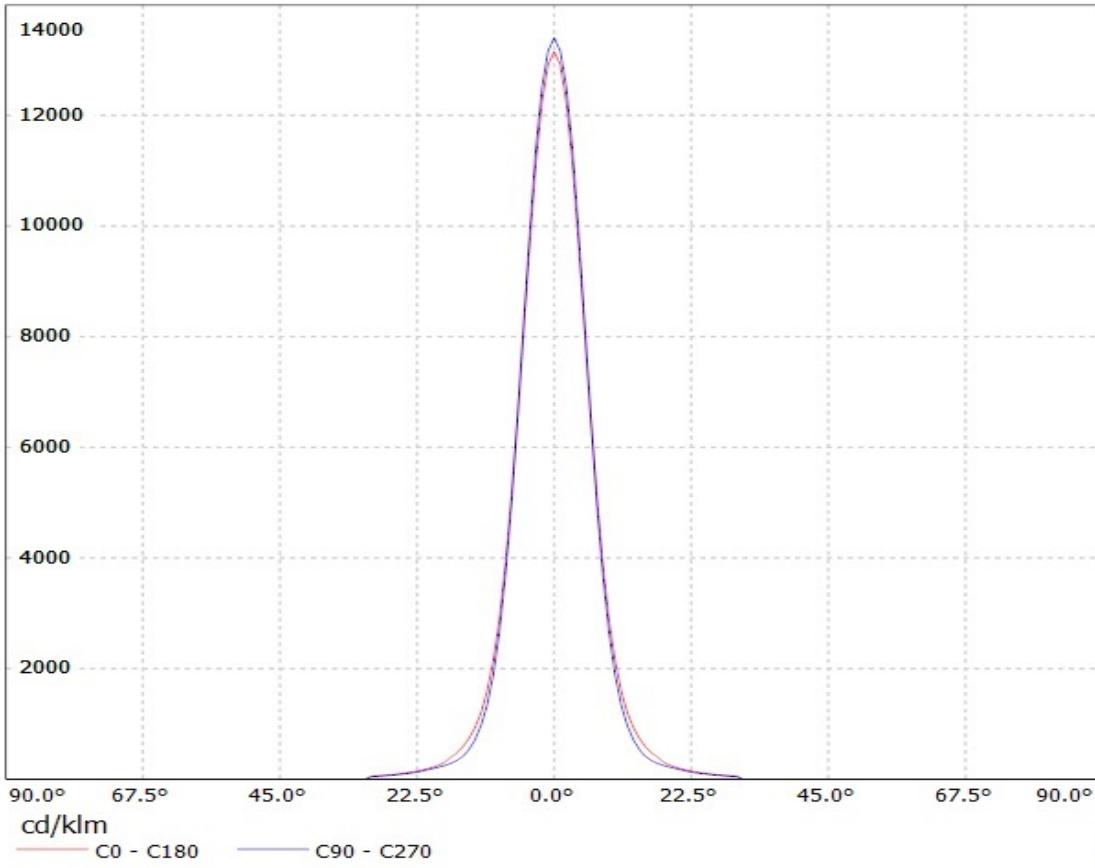

Ledil oy CA10559\_OSS-2-D (Golden Dragon+) LOR=92% / LDC (Linear)

Luminaire: Ledil oy CA10559\_OSS-2-D (Golden Dragon+) LOR=92%  
Lamps: 1 x Osram Golden Dragon+ 67lm @ 250mA

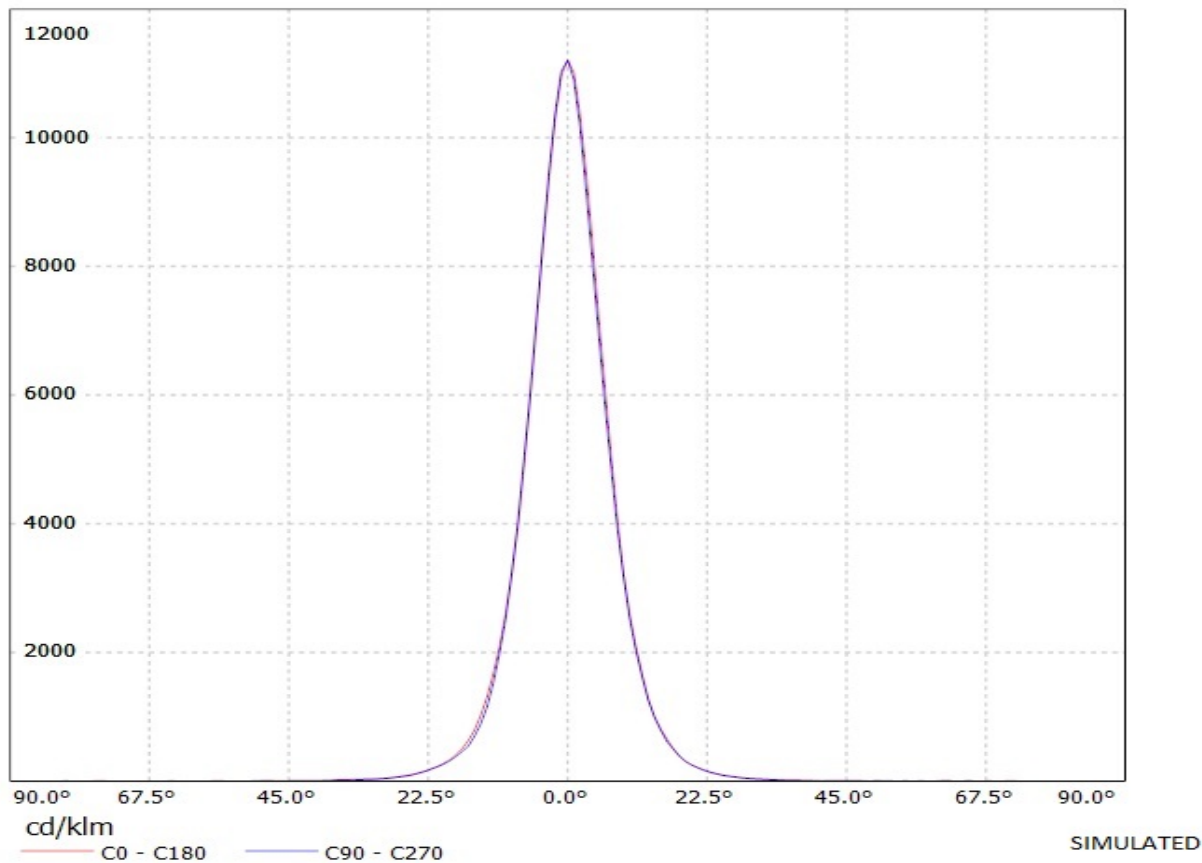

# Ledil Oy CA10572-OSS-2-O LOR=93% / LDC (Linear)

Luminaire: Ledil Oy CA10572-OSS-2-O LOR=93%  
Lamps: 1 x Golden dragon plus 80lm 250mA

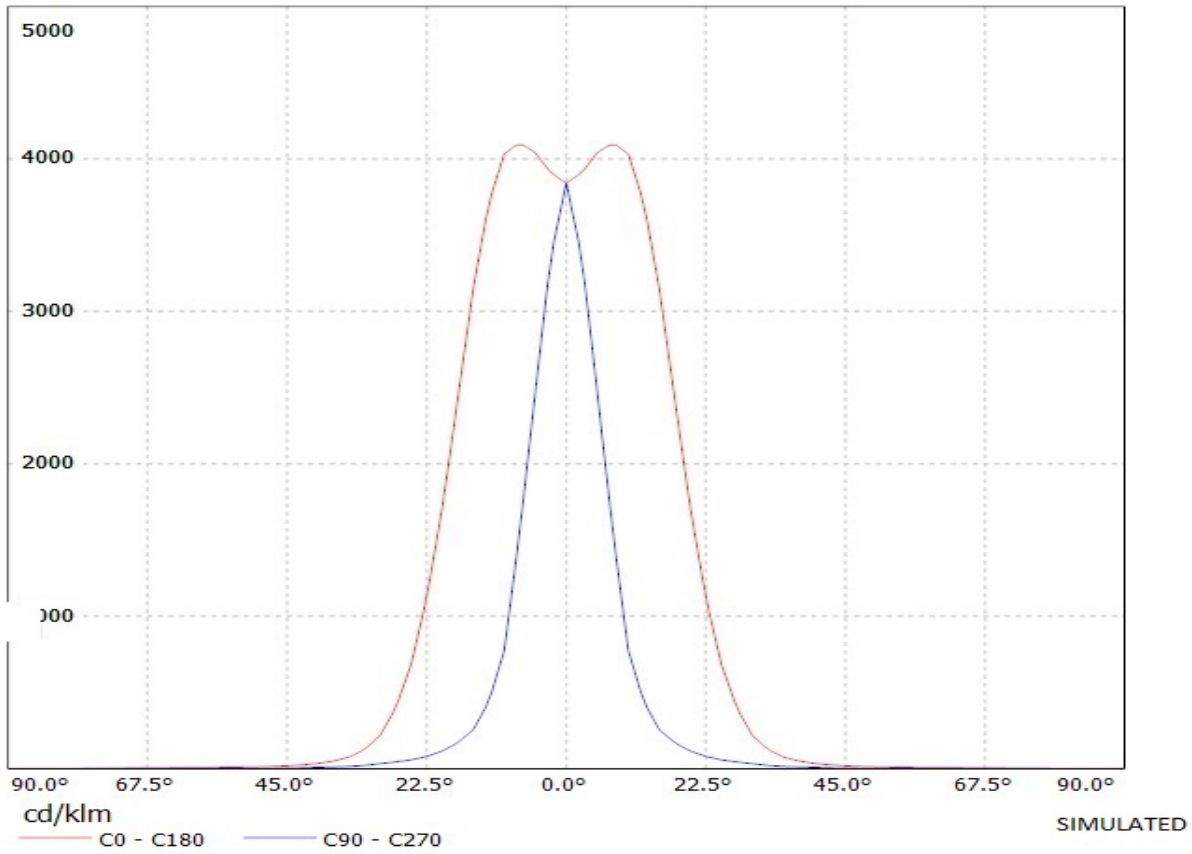

Ledil Oy CA10569\_OSS-2-M-GD+\_SIMULATED / LDC (Linear)

Luminaire: Ledil Oy CA10569\_OSS-2-M-GD+\_SIMULATED  
Lamps: 1 x Golden Dragon Plus 100lm

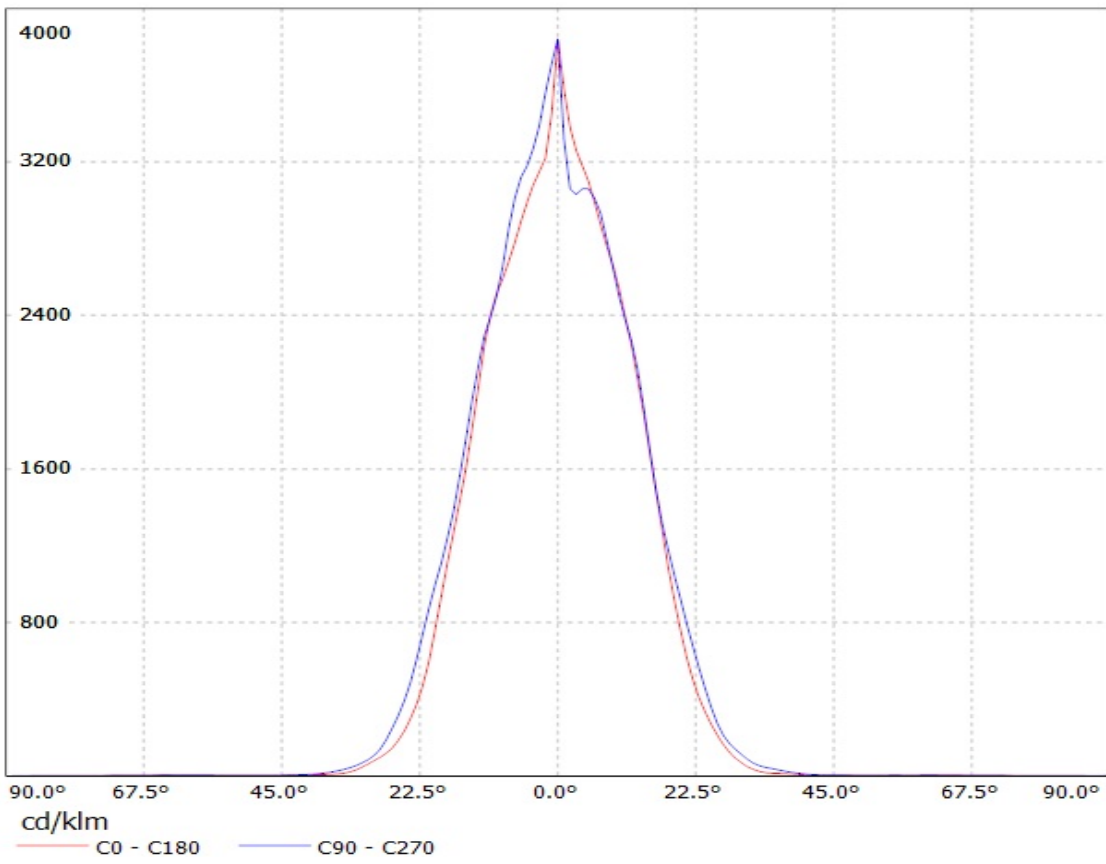



# Ledil Oy FA10301\_OSS-M FA10301\_OSS-M / LDC (Linear)

Luminaire: Ledil Oy FA10301\_OSS-M FA10301\_OSS-M  
Lamps: 1 x Osram-os Golden Dragon+

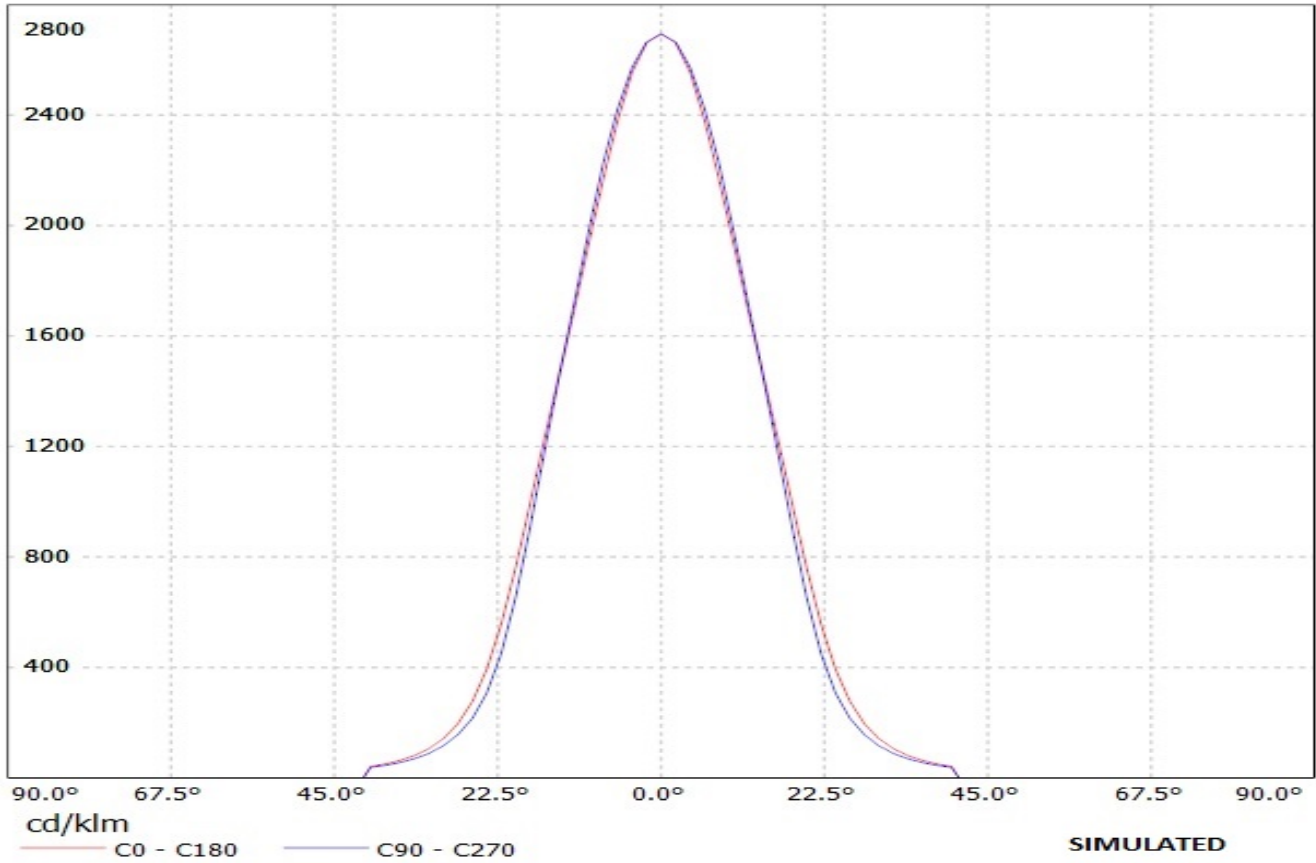

# Ledil Oy FA10302\_OSS-O FA10302\_OSS-O / LDC (Linear)

Luminaire: Ledil Oy FA10302\_OSS-O FA10302\_OSS-O  
Lamps: 1 x OSRAM-OS GOLDEN DRAGON+ (white)

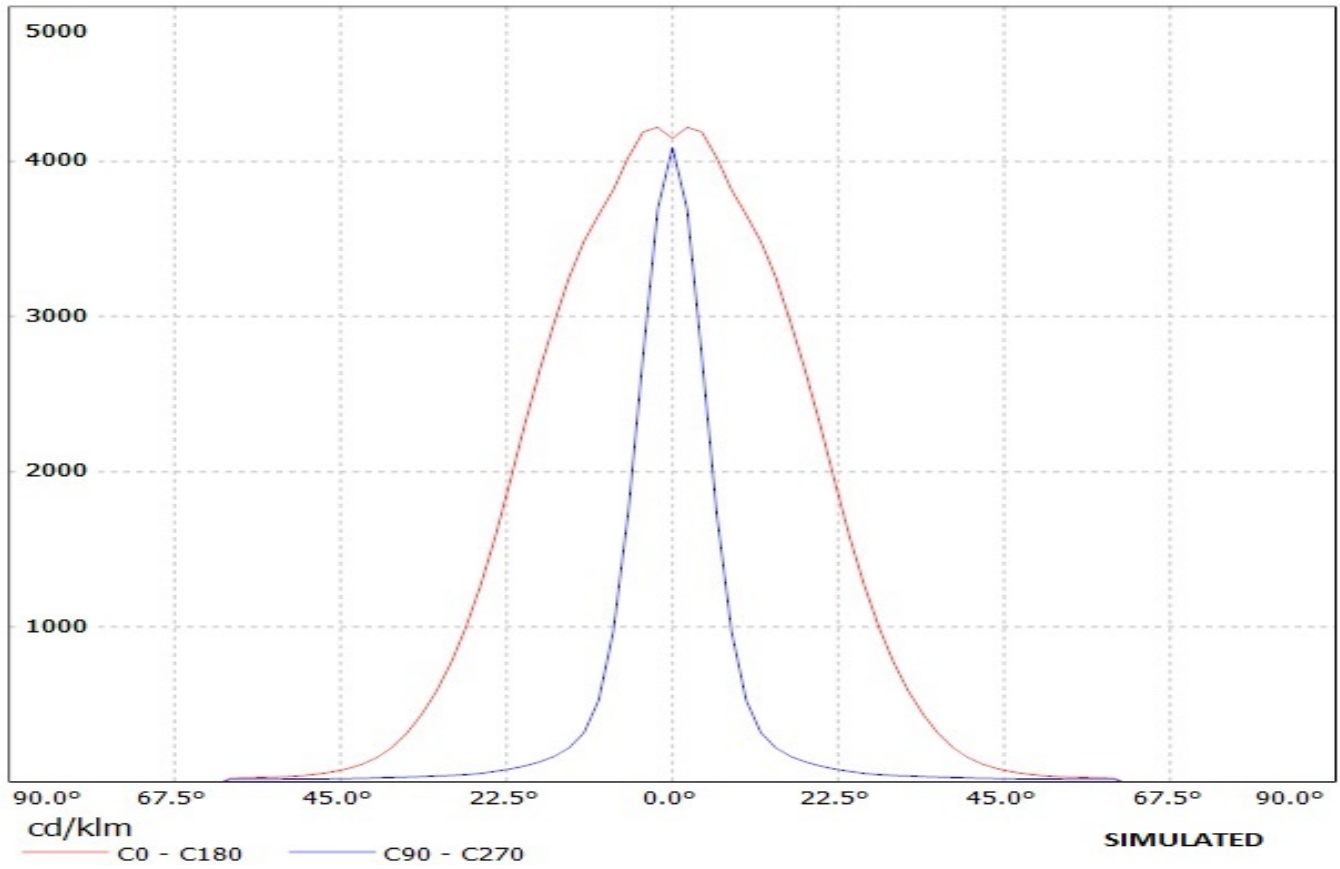

# Ledil Oy FA10299\_OSS-RS FA10299\_OSS-RS / LDC (Polar)

Luminaire: Ledil Oy FA10299\_OSS-RS FA10299\_OSS-RS  
Lamps: 1 x Osram-os Golden Dragon+

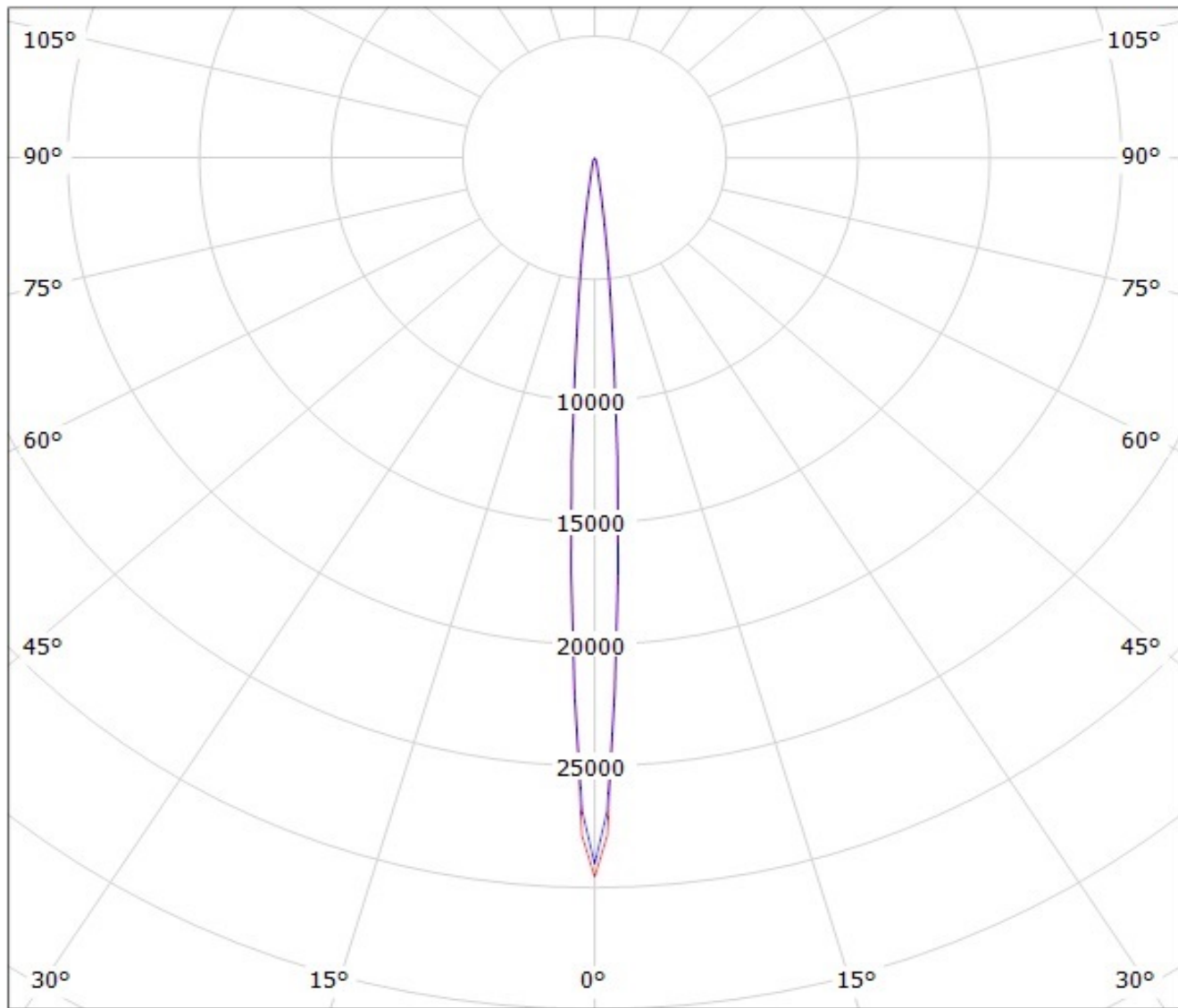

cd/klm

— C0 - C180

— C90 - C270

**SIMULATED**

# Ledil oy CA10561\_OSS-2-RS (Golden Dragon+) LOR=92% / LDC (Polar)

Luminaire: Ledil oy CA10561\_OSS-2-RS (Golden Dragon+) LOR=92%  
Lamps: 1 x Osram Golden Dragon+ 67lm @ 250mA

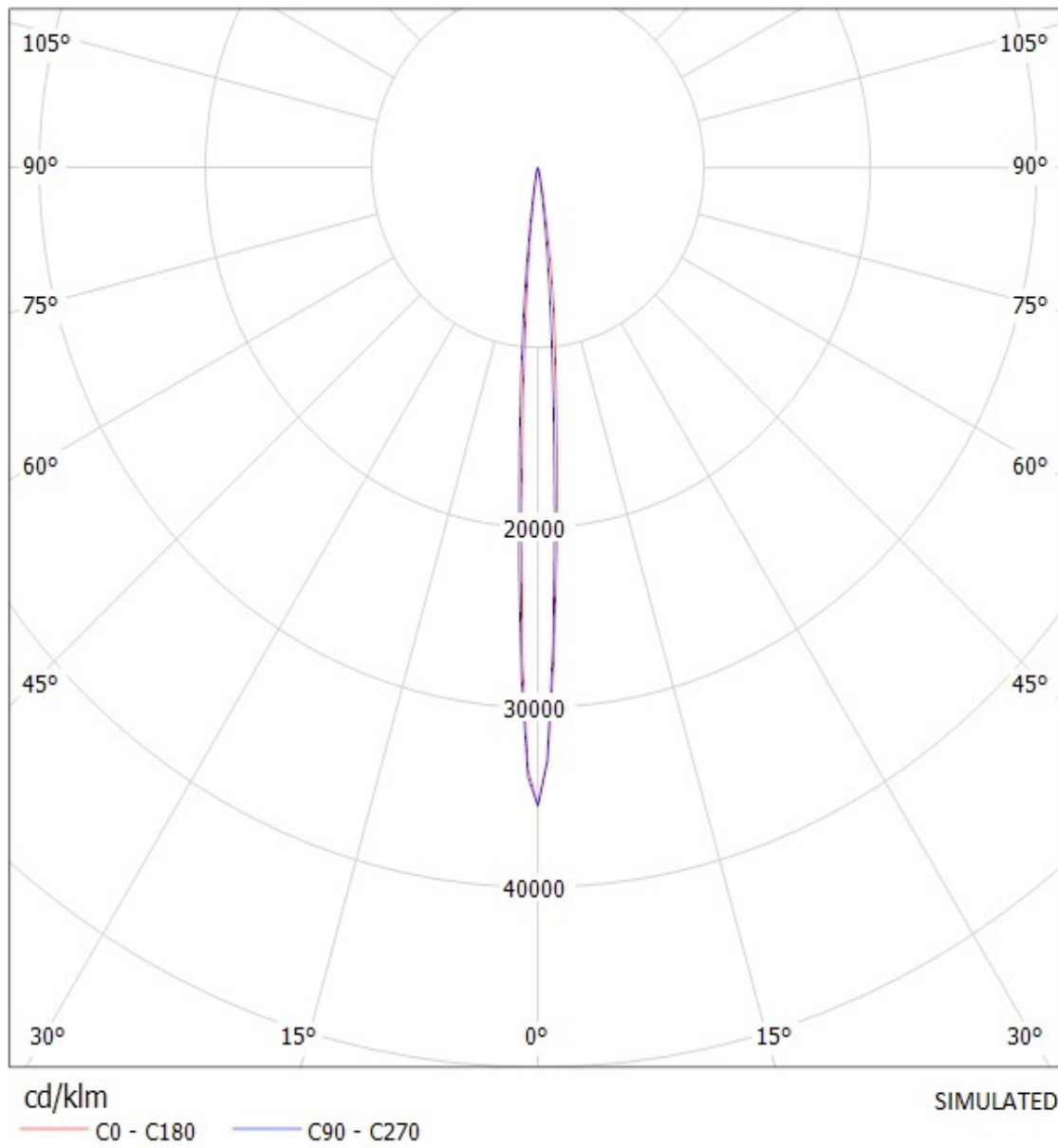

# Ledil Oy FA10300\_OSS-D FA10300\_OSS-D / LDC (Polar)

Luminaire: Ledil Oy FA10300\_OSS-D FA10300\_OSS-D

Lamps: 1 x OSRAM-OS GOLDEN DRAGON+ (white)

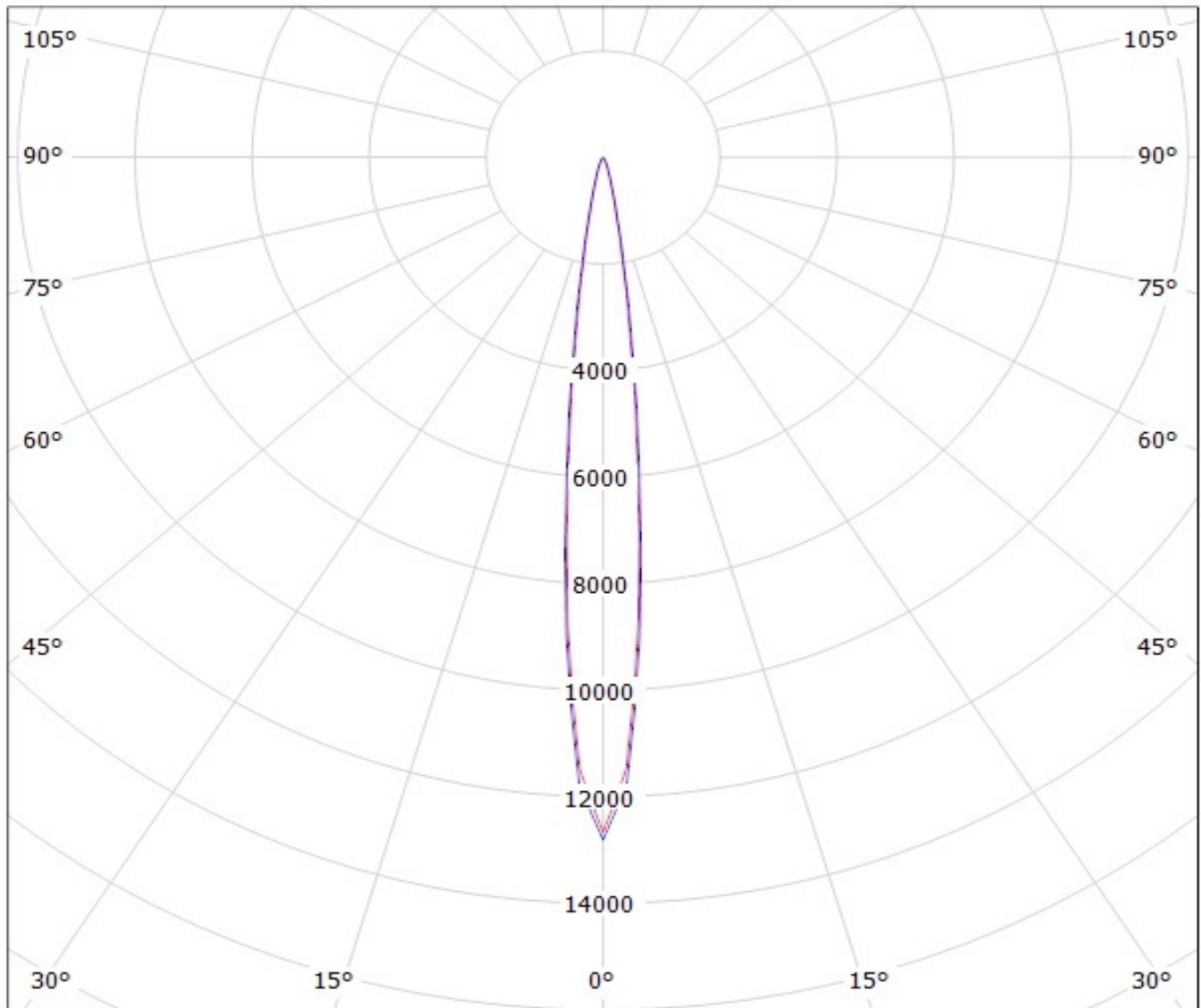

cd/klm

— C0 - C180

— C90 - C270

**SIMULATED**

# Ledil Oy FA10327\_OSS-SS FA10327\_OSS-SS / LDC (Polar)

Luminaire: Ledil Oy FA10327\_OSS-SS FA10327\_OSS-SS

Lamps: 1 x Osram-os Golden Dragon+

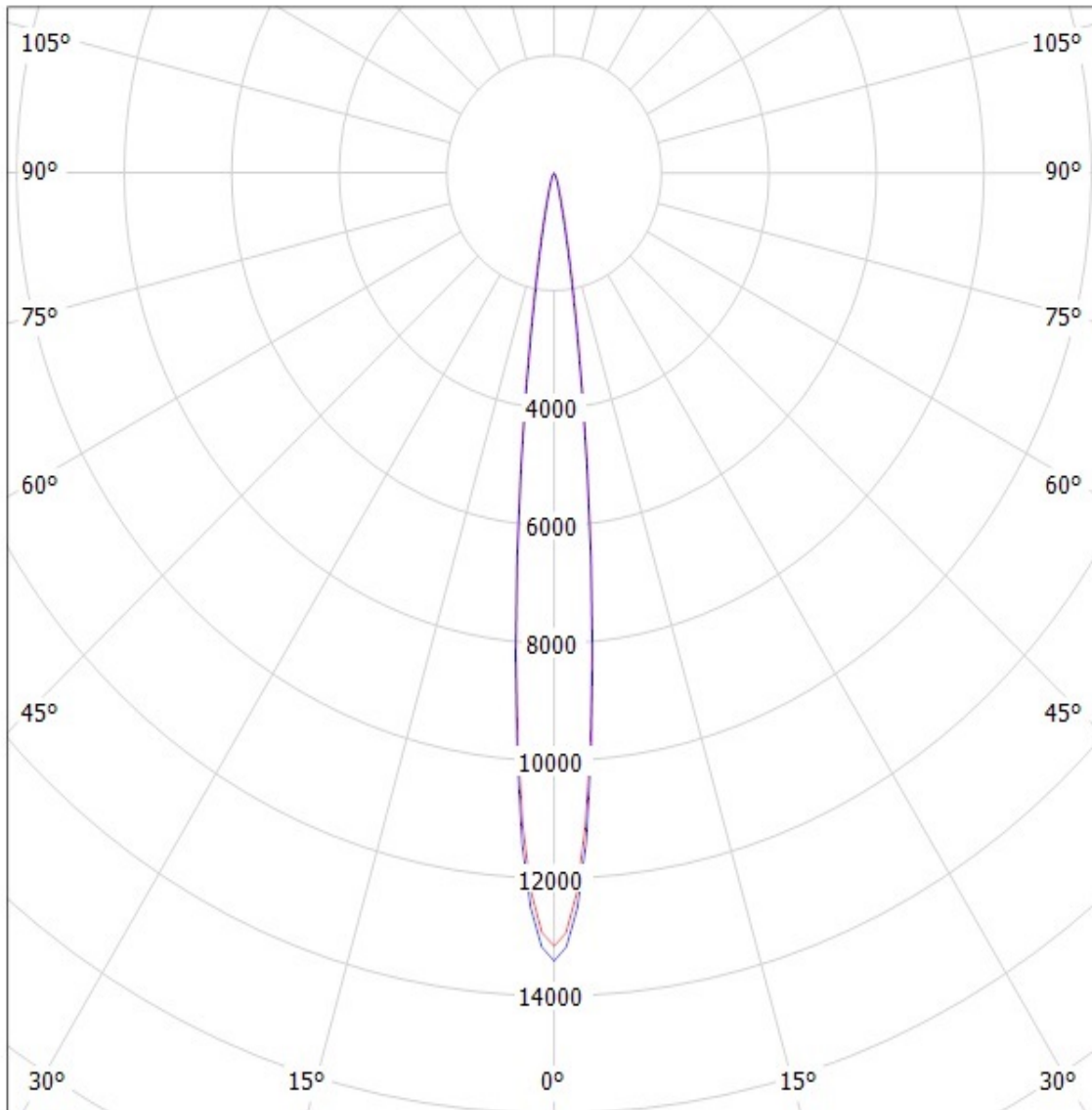

cd/klm

— C0 - C180 — C90 - C270

**SIMULATED**

# Ledil oy CA10559\_OSS-2-D (Golden Dragon+) LOR=92% / LDC (Polar)

Luminaire: Ledil oy CA10559\_OSS-2-D (Golden Dragon+) LOR=92%

Lamps: 1 x Osram Golden Dragon+ 67lm @ 250mA

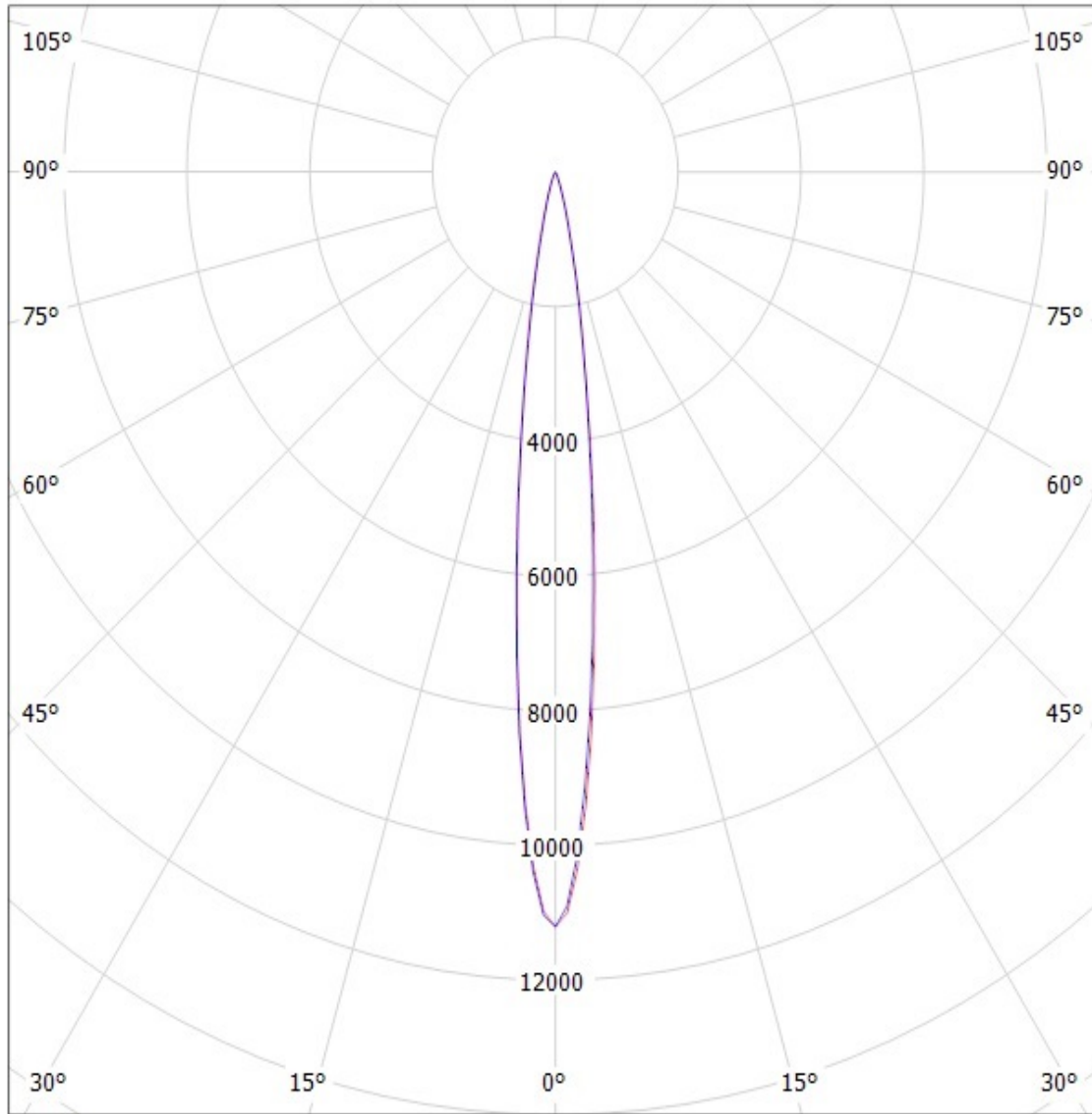

cd/klm

SIMULATED

— C0 - C180    — C90 - C270

# Ledil Oy CA10572-OSS-2-O LOR=93% / LDC (Polar)

Luminaire: Ledil Oy CA10572-OSS-2-O LOR=93%

Lamps: 1 x Golden dragon plus 80lm 250mA

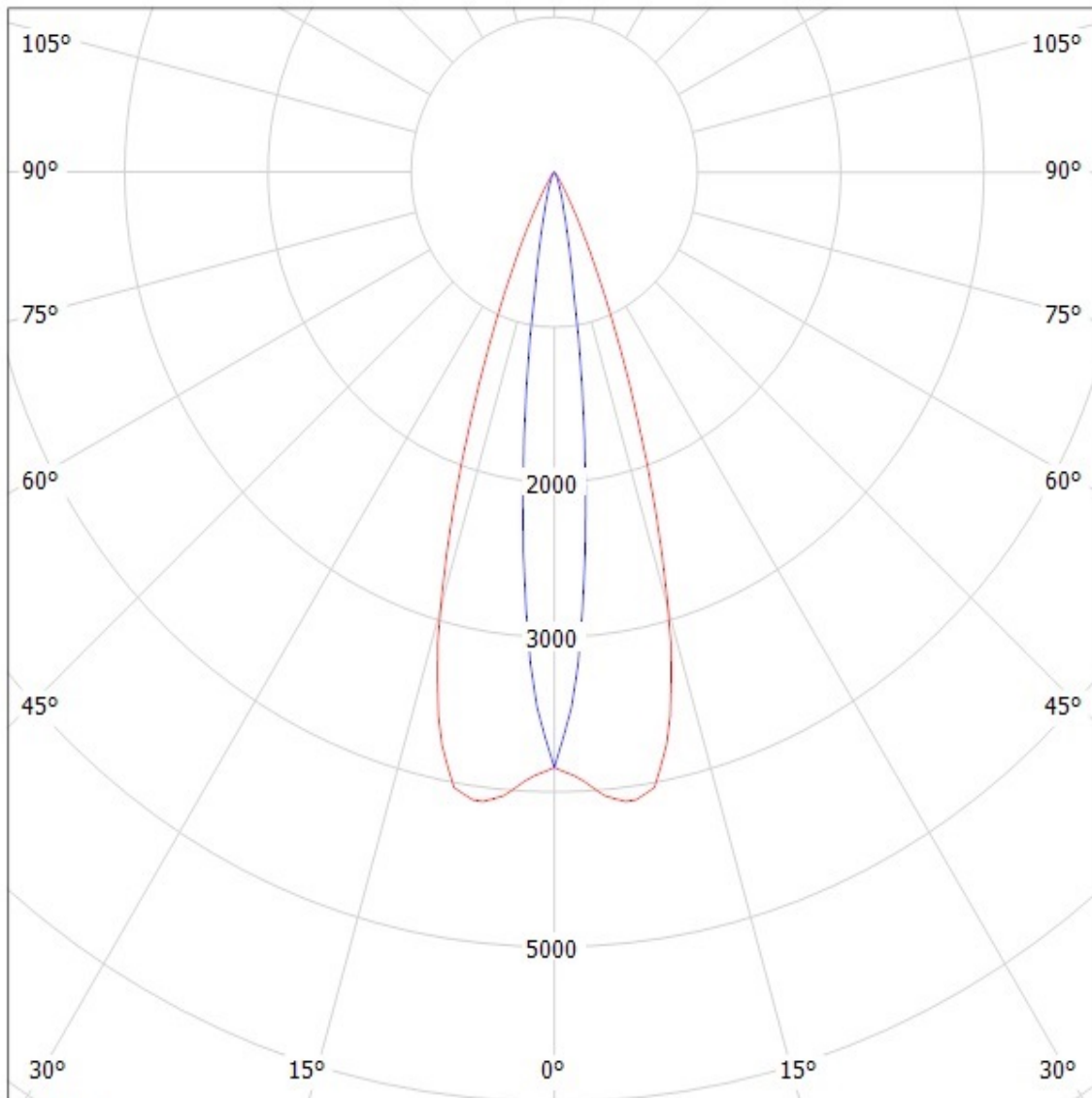

cd/klm

— C0 - C180

— C90 - C270

SIMULATED



# Ledil Oy CA10569\_OSS-2-M-GD+\_SIMULATED / LDC (Polar)

Luminaire: Ledil Oy CA10569\_OSS-2-M-GD+\_SIMULATED

Lamps: 1 x Golden Dragon Plus 100lm

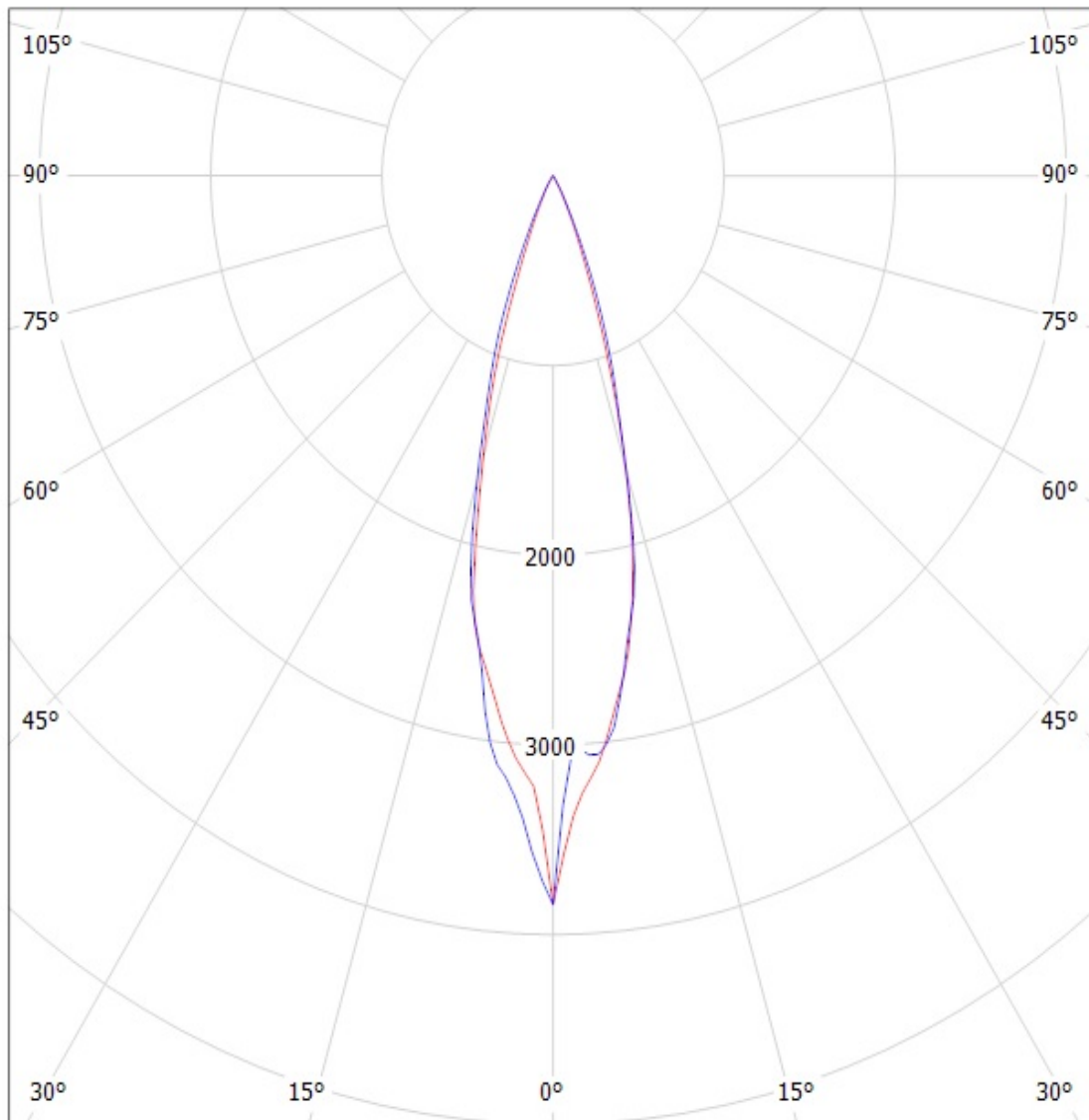

cd/klm

— C0 - C180

— C90 - C270

# Ledil Oy FA10301\_OSS-M FA10301\_OSS-M / LDC (Polar)

Luminaire: Ledil Oy FA10301\_OSS-M FA10301\_OSS-M

Lamps: 1 x Osram-os Golden Dragon+

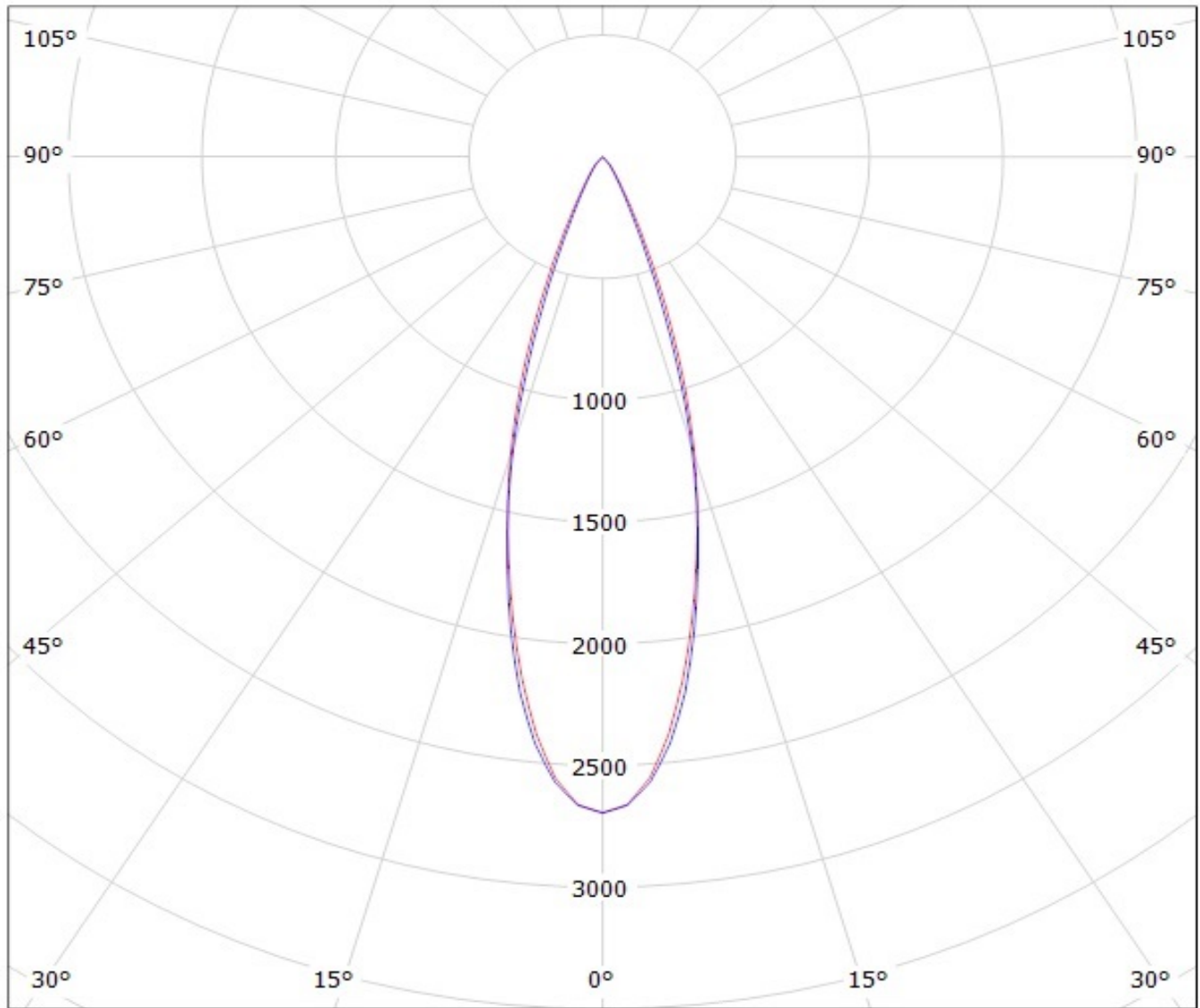

cd/klm

— C0 - C180

— C90 - C270

**SIMULATED**

# Ledil Oy FA10302\_OSS-O FA10302\_OSS-O / LDC (Polar)

Luminaire: Ledil Oy FA10302\_OSS-O FA10302\_OSS-O  
Lamps: 1 x OSRAM-OS GOLDEN DRAGON+ (white)

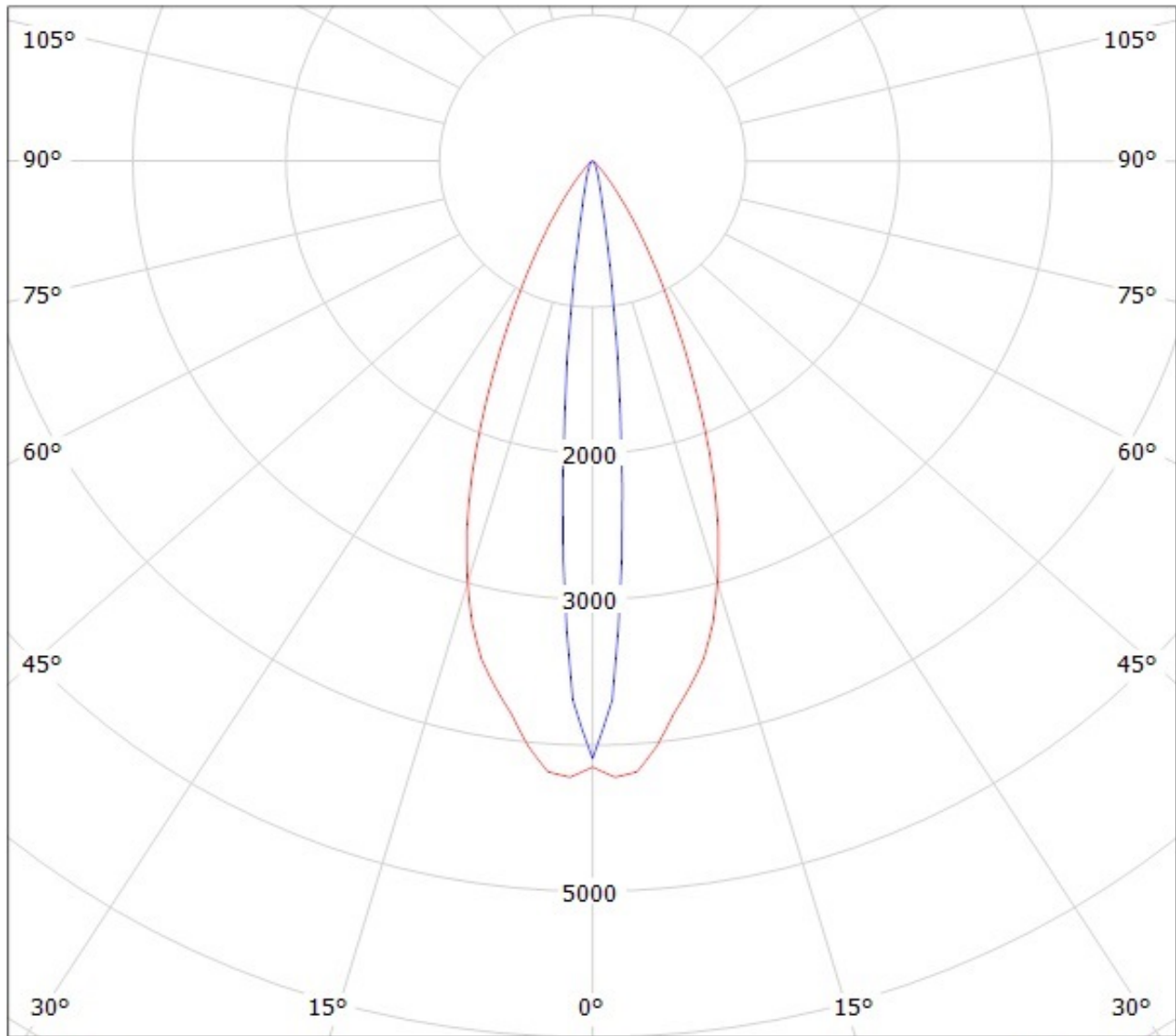

cd/klm

— C0 - C180

— C90 - C270

**SIMULATED**