

**Specifications: Military Unit**

Sound level Category	Loud Sound Level
Mode of Operation	Continuous
Mounting	Panel (see note B)
Voltage Rating	6 to 28 Vdc
Frequency	2900 Hz ±500 Hz
Loudness (Min. Voltage)	80 dB(A) min. @ 2 FT and 6 Vdc
Loudness (Max Voltage)	90 dB(A) min. @ 2FT and 28 Vdc
Current Draw	4 mA Max @ 6 Vdc
Current Draw	16 mA Max @ 28 Vdc
Storage Temperature	-65°C to +85°C
Operating Temperature	-40°C to +85°C
Weight (Typical)	1.5 oz (42 g)
Housing	6/6 Nylon, Color Black
Options	For other options contact factory

**Dimensions: Inches (mm)**

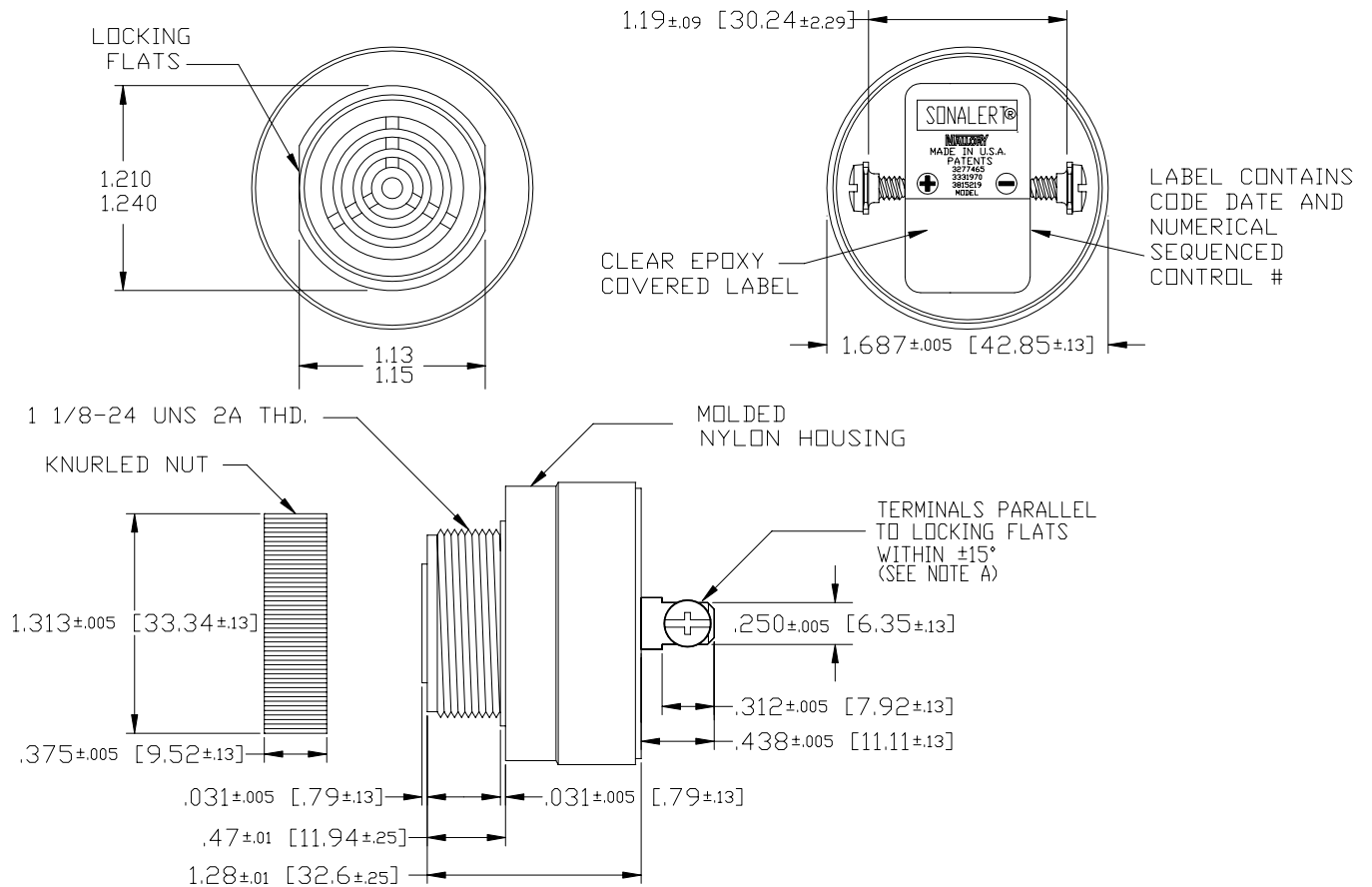

NOTE A: TERMINALS-.032 BRASS TIN PLATED, TAPPED FOR #6-32 SCREW. TWO #6-32 NICKEL PLATED BRASS SCREWS INCLUDED. WILL ACCEPT 1/4" QUICK CONNECT.

NOTE B: MOUNTING- REMOVE KNURLED NUT AND INSERT THREADED FRONT THROUGH 1.25" HOLE PUNCHED IN PANEL, IF ORIENTATION IS NEEDED, NOTE LOCKING FLATS ON DRAWING. SCREW NUT BACK ON. DO NOT OVERTIGHTEN.