

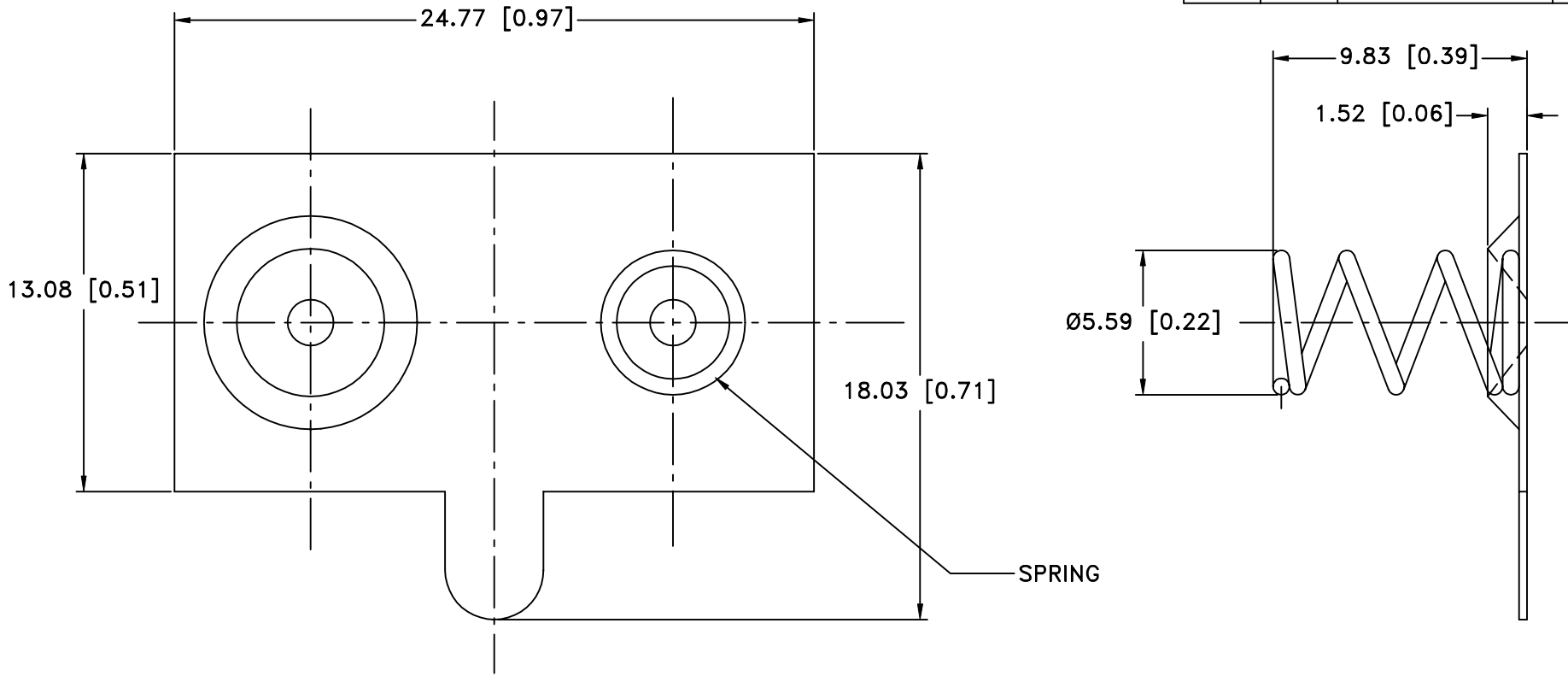

Date	SYM	REVISION RECORD	AUTH	DR.	CK.
10/04/03	A	BASE MATERIAL WAS BRASS	T.B.	B.S.	



NOTES:

1. BASE: STEEL, 0.3mm (0.012") THICK. NICKLE PLTD.
2. SPRING: STEEL, 0.61mm (0.024") THICK. NICKLE PLTD.

Tolerance (Except as noted)	 Memory Protection Devices, Inc 200 Broad Hollow Road, Farmingdale, New York 11735		
decimal ±.5 (.020)	Scale	Drawn By B.S. Approved By T.B.	
Fractional ± .8 (.030)	Title "AA" BATTERY COMMON CONTACT		
Angular ± 3°	Date 10/04/03	Drawing Number SN-T5-3	